

HX-V SERIES

LINEAR VELOCITY OUTPUT

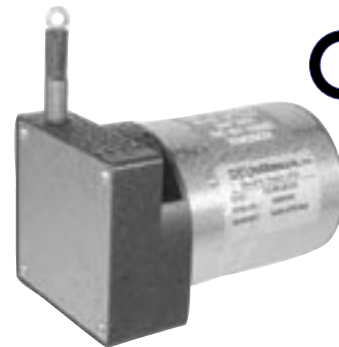

The UniMeasure HX-V series linear velocity transducer incorporates a self-generating tachometer which eliminates the need for any external power supply. Extra long brush life, excellent stability and a wide operating temperature range make the V series transducer highly reliable for long term service.



SPECIFICATIONS

General

Available Measurement Ranges .. See Supplemental Data¹, Table 12
 Connector MS3102E-14S-6P
 Mating Connector (included)..... MS3106E-14S-6S

Electrical

Output See Table 10
 Linearity ±0.10% F.S. within 25 Volt output
 Ripple..... 3% Max.
 Input..... None Required; Self Generating
 Output Impedance 350Ω
 Thermal Effects..... 0.01% Max. per Degree C
 through Range -20°C to 75°C

Environmental

Operating temperature..... -40°C to +95°C
 Storage Temperature -55° to +100°C
 Operating humidity..... 100%
 Vibration..... 10G's to 2KHz
 Shock..... 50 G's 0.1 ms Max.
 Ingress Protection
 Exclusive of Wire Rope Area.. NEMA 4 (IP-65)
 Optional Ingress Protection NEMA 6 (IP-68)

MEASUREMENT RANGE DESIGNATOR	VELOCITY OUTPUT	
	(mV per in/sec)	(mV per cm/sec)
2, 10	200	78
3, 15, 30	136	53
4, 20, 40	103	40
5, 25, 50	82	32
6, 60	69	27
80	52	20
100	180	71
ALL RANGES GREATER THAN 100*	180	71

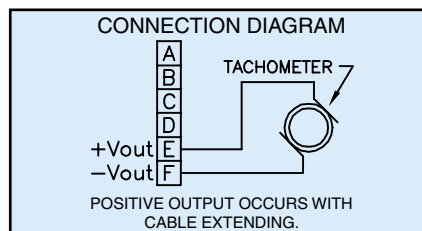

FOOTNOTES TO SPECIFICATIONS

1. Supplemental Data section located at end of HX Series pages.

Model Number Configuration

Range
 Select measurement range from Supplemental Data, Table 12, Insert corresponding Measurement Range Designator

Wire Rope
 * Stainless Steel (See Supplemental Data, Table 12)
NJC Ø.018 (0,45 mm) Nylon Jacketed Stainless Steel
 Ranges to 80" (2m) only.
NJC037 Ø.037 (0,94 mm) Nylon Jacketed Stainless Steel
 Ranges 100" (2.5m) to 500" (12.7m) only.

Wire Rope Tension
 * Standard
004..... Reduced (Ranges to 80" only)

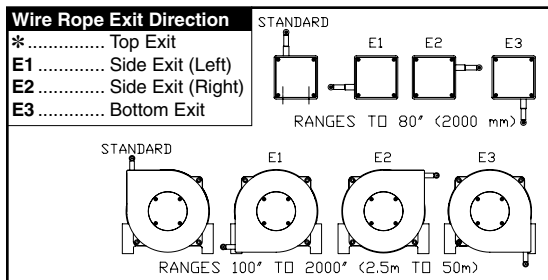

Electrical Interface
 * Mating Connector Included (See note 1 below)
L3M 3 m (10') electrical cable (See note 2 below)
L4M 4 m (13.5') electrical cable (See note 2 below)
L5M 5 m (16.5') electrical cable (See note 2 below)
L6M 6 m (20') electrical cable (See note 2 below)
L7M 7 m (23') electrical cable (See note 2 below)
 1. Applies to NEMA 4 Housing option only. Does not apply to N6 or SS Housing options.
 2. Select one of options L3M through L7M when electrical cable is required with mating connector when Housing option NEMA 4 is also selected. Select one of options L3M through L7M when Housing option N6 or SS is selected. Connector is **not** available with Housing option N6 or SS.



Housing
 * NEMA 4 (IP-65) Aluminum
N6 NEMA 6 (IP-68) Aluminum
SS NEMA 6 (IP-68) Corrosion Resistant Stainless Steel and Non-Metallic Construction

NOTE

- *—Asterisk items are standard configuration. No option designator is required.
- Shaded options available at additional cost.
- See Supplemental Data for options.

Example
HX-V-50-NJC-N6

ADDITIONAL OPTIONS

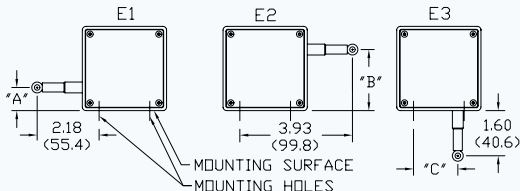
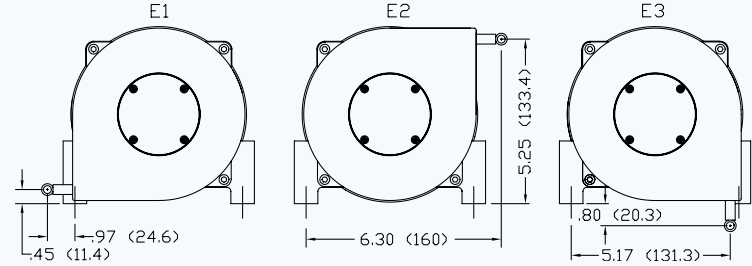
OPTION	OPTION DESIGNATOR	DESCRIPTION																												
Nylon jacketed wire rope (Ranges to 80" only)	NJC	Replaces standard stainless steel wire rope with Ø.018 nylon jacketed wire rope. This option increases wire rope life dramatically but may increase non-linearity by as much as ±.05% of full scale.																												
Nylon jacketed wire rope (Ranges 100" to 500" only)	NJC037	Replaces standard stainless steel wire rope with Ø.037 nylon jacketed wire rope.																												
Reversed output	R	Output is at a maximum when wire rope is fully retracted. Output decreases as wire rope is extended. Does not apply to velocity signal.																												
NEMA 6, IP-68 capability	N6	 Connector is replaced with a bulkhead fitting and a designated length of urethane jacketed, shielded, twisted pair cable. Retraction mechanism and electrical components are sealed to NEMA 6, IP-68 capability. No connector.																												
Corrosion Resistant Construction	SS	All external anodized aluminum parts of transducer are replaced with stainless steel and corrosion resistant plastic. Transducer is sealed to NEMA 6, IP-68 capability. Urethane jacketed, shielded, twisted pair cable exits unit. No connector. 																												
Non-standard potentiometer (Applies to HX-PA only)	PXK	Replace "X" in option designator with required potentiometer value in K ohms. Non-standard potentiometer linearity is as follows: Ranges 0 to 2" to 0 to 5" ±1.00% of full scale Ranges 0 to 10" to 0 to 25" ±0.50% of full scale Ranges 30" and above ±0.25% of full scale Note: This option is subject to potentiometer availability.																												
Alternate wire rope exit Measurement ranges to 80" (2.0 m)	E1, E2, E3	 <table border="1" data-bbox="649 1386 1166 1612"> <thead> <tr> <th>RANGE</th> <th>"A"</th> <th>"B"</th> <th>"C"</th> </tr> </thead> <tbody> <tr> <td>2", 10"</td> <td>1.12 (28.4)</td> <td>1.79 (45.5)</td> <td>1.21 (30.7)</td> </tr> <tr> <td>3", 15", 30"</td> <td>.96(24.4)</td> <td>1.95 (49.5)</td> <td>1.37 (34.8)</td> </tr> <tr> <td>4", 20", 40"</td> <td>.80 (20.3)</td> <td>2.11 (53.6)</td> <td>1.53 (38.9)</td> </tr> <tr> <td>5", 25", 50"</td> <td>.64 (16.3)</td> <td>2.27 (57.7)</td> <td>1.69 (42.9)</td> </tr> <tr> <td>6", 60"</td> <td>.49 (12.4)</td> <td>2.42 (61.5)</td> <td>1.84 (46.7)</td> </tr> <tr> <td>80"</td> <td>.25 (6.4)</td> <td>2.66 (67.6)</td> <td>2.08 (52.8)</td> </tr> </tbody> </table> <p style="text-align: right;">Dimensions in brackets are millimeters.</p>	RANGE	"A"	"B"	"C"	2", 10"	1.12 (28.4)	1.79 (45.5)	1.21 (30.7)	3", 15", 30"	.96(24.4)	1.95 (49.5)	1.37 (34.8)	4", 20", 40"	.80 (20.3)	2.11 (53.6)	1.53 (38.9)	5", 25", 50"	.64 (16.3)	2.27 (57.7)	1.69 (42.9)	6", 60"	.49 (12.4)	2.42 (61.5)	1.84 (46.7)	80"	.25 (6.4)	2.66 (67.6)	2.08 (52.8)
RANGE	"A"	"B"	"C"																											
2", 10"	1.12 (28.4)	1.79 (45.5)	1.21 (30.7)																											
3", 15", 30"	.96(24.4)	1.95 (49.5)	1.37 (34.8)																											
4", 20", 40"	.80 (20.3)	2.11 (53.6)	1.53 (38.9)																											
5", 25", 50"	.64 (16.3)	2.27 (57.7)	1.69 (42.9)																											
6", 60"	.49 (12.4)	2.42 (61.5)	1.84 (46.7)																											
80"	.25 (6.4)	2.66 (67.6)	2.08 (52.8)																											
Alternate wire rope exit Measurement ranges 100" (2.5 m) and greater.	E1, E2, E3	 <p style="text-align: center;">Dimensions in brackets are millimeters.</p>																												

Specifications subject to change without notice.

HX SERIES

SUPPLEMENTAL DATA

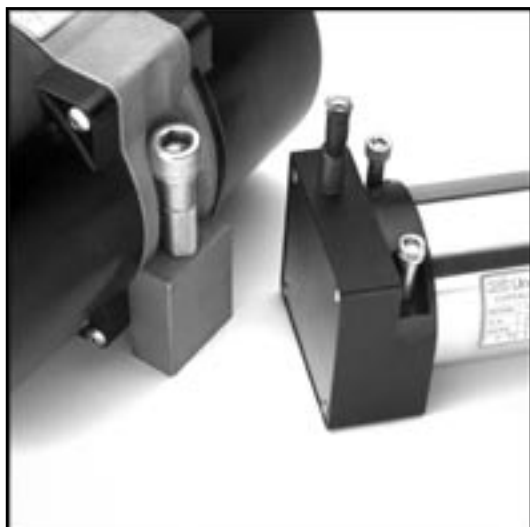

Typical HX mounting bolts.

MECHANICAL SPECIFICATIONS

Mechanical Specifications

Available Measurement Ranges.....	See Table 12
Construction	
Ranges 80" (2 m) and under.....	Anodized Aluminum Mounting Base, Stainless Steel & Anodized Aluminum Housing
Ranges 100" (2.5 m) and greater	Stainless Steel Mounting Base High Impact, Corrosion Resistant Thermoplastic Housings
Wire Rope Tension	See Table 12
Wire Rope Diameter.....	See Table 12
Weight	See Table 12
Connector.....	MS3102A-14S-6P
Mating Connector (included)	MS3106E-14S-6S
Optional NEMA 6 Capability.....	Bulkhead fitting with shielded, twisted pair cable
Life*	
Ranges 2" to 6"	5,000,000 full stroke cycles
Ranges 10" to 25"	500,000 full stroke cycles
Ranges 30" to 400"	250,000 full stroke cycles
Ranges 500" to 2000"	200x10 ⁶ lineal inches

* with 1K ohm potentiometer, wire rope misalignment 2° maximum at full stroke, relatively dust free environment, nylon jacketed wire rope on units with ranges 80" and less.

Use value from this column to indicate overall measurement range

Check mark indicates available measurement range

TABLE 12

MEASUREMENT RANGE DESIGNATOR	STANDARD MEASUREMENT RANGES		APPLICABLE SERIES			WIRE ROPE TENSION (NOMINAL)		WIRE ROPE DIAMETER		TRANSDUCER WEIGHT		Product Photo	
	(in)	(mm)	HX-PA HX-PB HX-P420 HX-P510 HX-P1010	HX-EP	HX-V HX-VP	(oz)	(N)	(in)	(mm)	(lb)	(Kg)		
2	2	50	✓	-	✓	34	9.4	.016	0.4	2	0.9		
3	3	75	✓	-	✓	24	6.7	.016	0.4	2	0.9		
4	4	100	✓	-	✓	24	6.7	.016	0.4	2	0.9		
5	5	125	✓	-	✓	19	5.3	.016	0.4	2	0.9		
6	6	150	✓	-	✓	24	6.7	.016	0.4	2	0.9		
10	10	250	✓	✓	✓	34	9.4	.016	0.4	2	0.9		
15	15	390	✓	-	✓	24	6.7	.016	0.4	2	0.9		
20	20	500	✓	-	✓	24	6.7	.016	0.4	2	0.9		
25	25	640	✓	✓	✓	19	5.3	.016	0.4	2	0.9		
30	30	750	✓	-	✓	24	6.7	.016	0.4	2	0.9		
40	40	1000	✓	-	✓	24	6.7	.016	0.4	2	0.9		
50	50	1250	✓	✓	✓	19	5.3	.016	0.4	2	0.9		
60	60	1500	✓	✓	✓	24	6.7	.016	0.4	2	0.9		
80	80	2.0m	✓	✓	✓	21	5.8	.016	0.4	2	0.9		
100	100	2.5m	✓	✓	✓	36	10.0	.024	0.6	6.8	3.1		
120	120	3.0m	✓	✓	✓	36	10.0	.024	0.6	6.8	3.1		
150	150	3.8m	✓	✓	✓	36	10.0	.024	0.6	6.8	3.1		
200	200	5.0m	✓	✓	✓	36	10.0	.024	0.6	6.8	3.1		
250	250	6.3m	✓	✓	✓	36	10.0	.024	0.6	6.8	3.1		
300	300	7.5m	✓	✓	✓	36	10.0	.024	0.6	6.8	3.1		
350	350	8.8m	✓	✓	✓	36	10.0	.024	0.6	6.8	3.1		
400	400	10.0m	✓	✓	✓	36	10.0	.024	0.6	6.8	3.1		
500	500	12.5m	✓	✓	✓	36	10.0	.024	0.6	8.6	3.9		
600	600	15.2m	✓	✓	✓	36	10.0	.024	0.6	8.6	3.9		
800	800	20.3m	✓	✓	✓	36	10.0	.024	0.6	8.6	3.9		
1000	1000	25.4m	✓	✓	-	36	10.0	.024	0.6	12.0	5.4		
1200	1200	30.4m	✓	✓	-	36	10.0	.024	0.6	12.3	5.6		
1600	1600	40.6m	✓	✓	-	36	10.0	.024	0.6	14.1	6.4		
1800	1800	45.7m	✓	✓	-	36	10.0	.021	0.6	15.9	7.2		
2000	2000	50.8m	✓	✓	-	36	10.0	.021	0.5	16.3	7.4		

Specifications subject to change without notice.

DIMENSIONAL INFORMATION

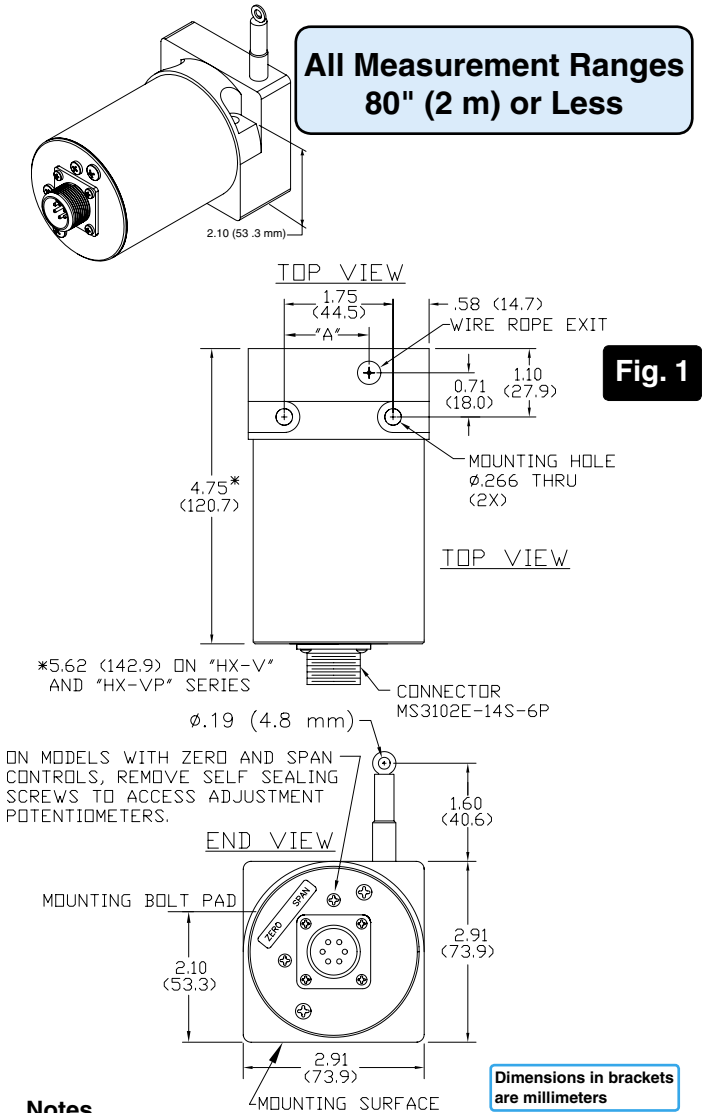

Notes

1. Transducer mounts with Ø.25 or M6 socket head cap bolts.

Table 13

RANGE	"A"
2", 10"	1.21 (30.7)
3", 15", 30"	1.37 (34.8)
4", 20", 40"	1.53 (38.9)
5", 25", 50"	1.69 (42.9)
60"	1.84 (46.7)
80"	2.08 (52.8)

Table 14

RANGE	DIM "A"	DIM "B"
Ranges to 800"	7.70 (196)	3.80 (97)
1000" to 2000"	11.0 (280)	5.60 (142)

Notes

1. Transducer mounts with Ø.50 or M12 socket head cap bolts.
2. Dimension "C" is the cable offset that occurs as the cable is extended from the transducer.

For "C" in inches, $C = .0016 \times E$ where E = extension in inches.

For "C" in millimeters, $C = .0016 \times E$ where E = extension in mm.

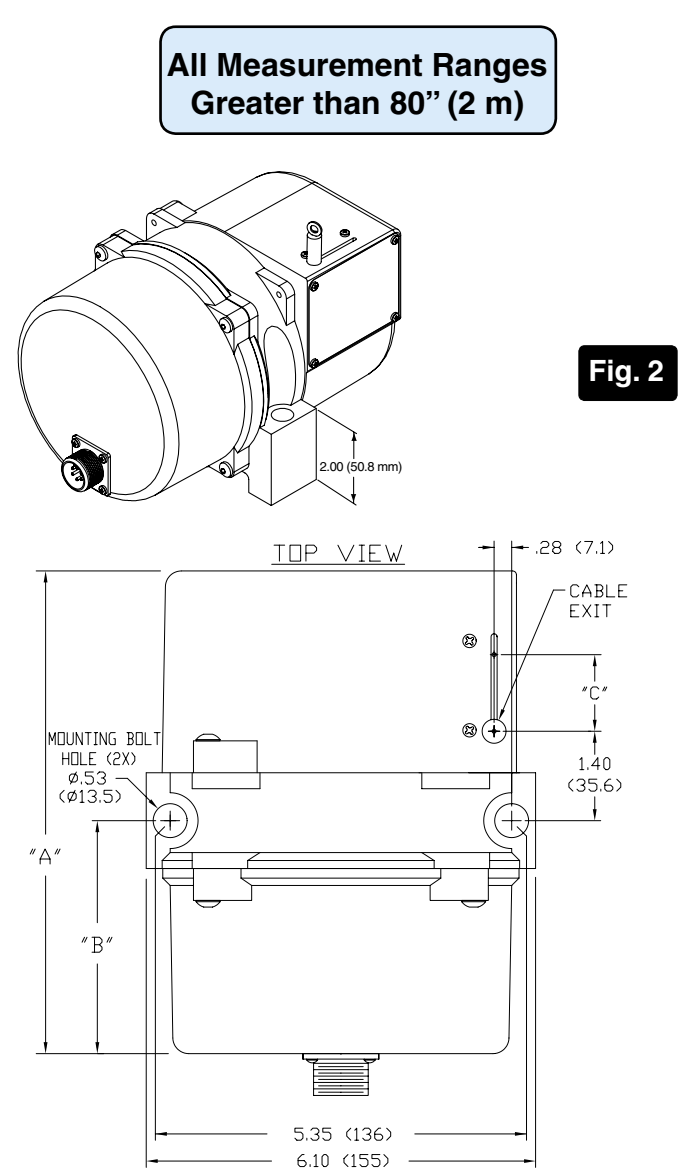

Dimensions in brackets are millimeters

Specifications subject to change without notice.